

Standardne kabelske vezice

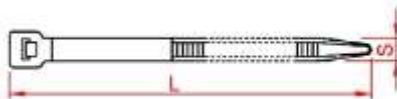

šifra artikla		naziv artikla	L x S (mm)		
bijela	crna				
491507	491508	Vezica 75x2,2	75 x 2,2	0,75-15mm	35 N
491509	491510	Vezica 98x2,5	98 x 2,5	1-21mm	45 N
491511	491512	Vezica 135x2,6	135 x 2,6	1-32mm	45 N
491513	491514	Vezica 140x3,6	140 x 3,6	2-36mm	80 N
491515	491516	Vezica 160x2,6	160 x 2,6	1-40mm	45 N
491517	491518	Vezica 180x7,8	180 x 7,8	3,5-45mm	250 N
491519	491520	Vezica 200x2,6	200 x 2,6	1-52mm	45 N
491521	491522	Vezica 200x3,6	200 x 3,6	2-50mm	80 N
491523	491524	Vezica 200x4,8	200 x 4,8	3-50mm	110 N
491525	491526	Vezica 250x4,8	250 x 4,8	3-68mm	110 N
491527	491528	Vezica 260x2,5	260 x 2,5	3-73mm	45 N
491500	491501	Vezica 280x8,0	280 x 8,0	4-65mm	180 N
491529	491530	Vezica 290x3,6	290 x 3,6	2-80mm	80 N
491531	491532	Vezica 290x4,8	290 x 4,8	3,5-79mm	110 N
491647	491648	Vezica 300x7,8	300 x 7,8	5-80mm	250 N
491533	491646	Vezica 360x4,8	360 x 4,8	3,5-103mm	110 N
491649	491650	Vezica 365x7,8	365 x 7,8	8-100mm	250 N
491651	491652	Vezica 370x3,6	370 x 3,6	5-108mm	80 N
491653	491654	Vezica 430x4,8	430 x 4,8	3,5-115mm	110 N
491655	491656	Vezica 450x7,8	450 x 7,8	35-130mm	250 N
491642	491643	Vezica 550x4,6	550 x 4,6	4-160mm	110 N
491659	491660	Vezica 550x8,0	550 x 8,0	10-160mm	250 N
491502	491503	Vezica 580x12,4	580 x 12,4	9-168mm	450 N
491657	491658	Vezica 610x8,8	610 x 8,8	9-181mm	350 N
491661	491662	Vezica 780x9	780 x 9,0	35-233mm	350 N
491663	491664	Vezica 850x12,6	850 x 12,6	40-255mm	450 N
491644	491645	Vezica 1000x12,6	1000 x 12,6	40-302mm	450 N

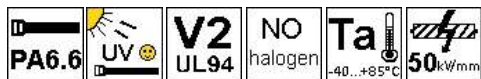
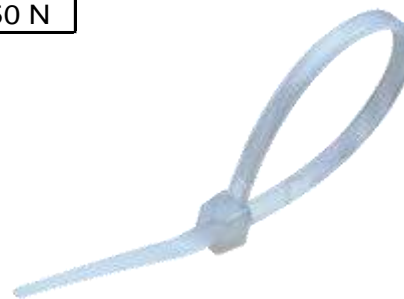

Kliješta za vezice



493339



493340

Trajno otporna na: derivate ugljikovodika, organska otapala, alkohole
 Umjereno otporna na: organske kiseline, lužine, neorganske soli i druge organske tvari
 Nije otporna na: neorgansku kiselinu, oksidacijska sredstva

Kabelske vezice u boji

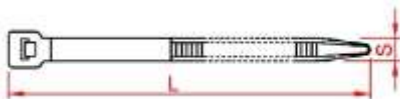
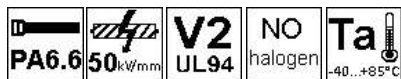

šifra artikla	naziv artikla		L x S (mm)		
490508	Vezica 98x2,5 plava		98 x 2,5 mm	1-21 mm	45 N
490509	Vezica 140x3,6 crvena		140 x 3,6 mm	2-36 mm	80 N
490510	Vezica 140x3,6 zelena		140 x 3,6 mm	2-36 mm	80 N
490514	Vezica 140x3,6 žuta		140 x 3,6 mm	2-36 mm	80 N
490512	Vezica 200x2,6 plava		200 x 2,6 mm	1-52 mm	45 N
490507	Vezica 200x3,6 crvena		200 x 3,6 mm	2-50 mm	80 N
490511	Vezica 200x3,6 zelena		200 x 3,6 mm	2-50 mm	80 N
490515	Vezica 200x3,6 plava		200 x 3,6 mm	2-50 mm	80 N
490517	Vezica 200x4,8 plava		200 x 4,8 mm	3-50 mm	110 N
490516	Vezica 203x4,6 zelena		203 x 4,6 mm	2-52 mm	110 N
490513	Vezica 290x3,6 neon zelena		290 x 3,6 mm	2-80 mm	80 N

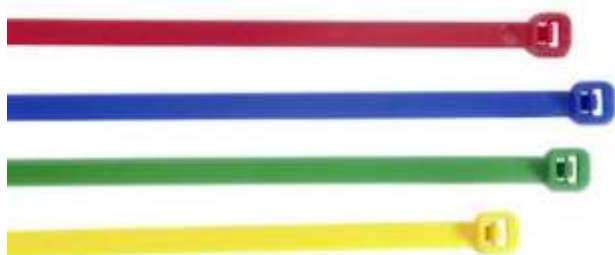

Kabelske vezice sa metalnim jezičkom

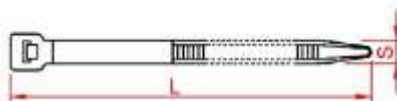
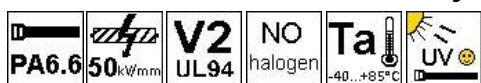

šifra artikla	naziv artikla		L x S (mm)			
491666	Vezica T 94x2,4 bijela		92 x 2,4	2-16 mm	35 N	 UV-otporne
491667	Vezica T 140x3,6 bijela		140 x 3,6	2-29 mm	75 N	
491668	Vezica T 186x4,6 bijela		186 x 4,6	3,5-45 mm	110 N	
491669	Vezica T 200x2,4 bijela		200 x 2,4	2-50 mm	35 N	
491670	Vezica T 208x3,6 bijela		208 x 3,6	2-50 mm	75 N	
491671	Vezica T 281x3,6 bijela		281 x 3,6	2-76 mm	75 N	
491672	Vezica T 293x4,8 bijela		293 x 4,8	3,5-78 m	110 N	
491673	Vezica T 338x7,6 bijela		338 x 7,6	3,5-120 mm	110 N	
491674	Vezica T 360x4,8 bijela		360 x 4,8	3,5-102 mm	110 N	
492485	Vezica TU 92x2,4 crna		92 x 2,4	2-16 mm	35 N	
492486	Vezica TU 140x3,6 crna		140 x 3,6	2-29 mm	75 N	
492487	Vezica TU 186x4,8 crna		186 x 4,6	3,5-45 mm	110 N	
492488	Vezica TU 200x2,4 crna		200 x 2,4	2-50 mm	35 N	
492489	Vezica TU 208x3,6 crna		208 x 3,6	2-50 mm	75 N	
492490	Vezica TU 281x3,6 crna		281 x 3,6	2-76 mm	75 N	
492491	Vezica TU 293x4,8 crna		293 x 4,8	3,5-78 m	110 N	
492492	Vezica TU 338x7,6 crna		338 x 7,6	3,5-120 mm	110 N	
492493	Vezica TU 360x4,8 crna		360 x 4,8	3,5-102 mm	110 N	

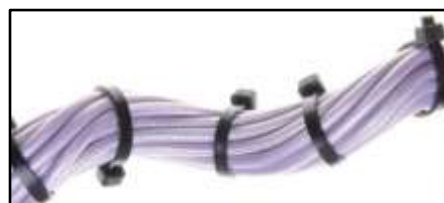

Kabelske vezice PA12

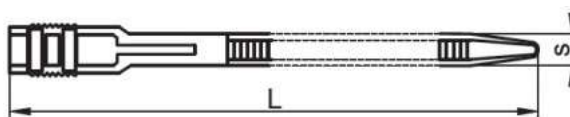
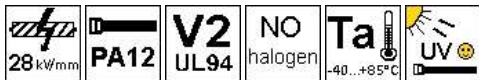

šifra artikla	naziva artikla		L x S (mm)		
492494	Vezica PA12 132x9,0 crna		132 x 9,0 mm	4-27 mm	120 N
492495	Vezica PA12 180x9,0 crna		180 x 9,0 mm	5-45 mm	150 N
492496	Vezica PA12 260x9,0 crna		260 x 9,0 mm	25-65 mm	250 N
492497	Vezica PA12 300x9,0 crna		300 x 9,0 mm	25-80 mm	225 N
492498	Vezica PA12 350x9,0 crna		350 x 9,0 mm	25-93 mm	250 N

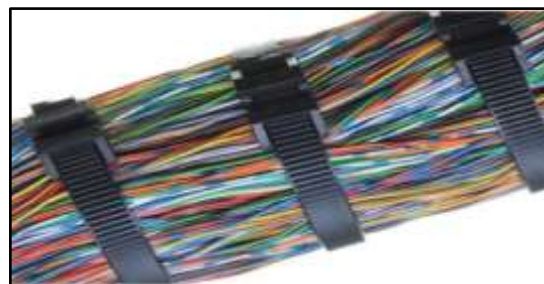

Odvezive kabelske vezice

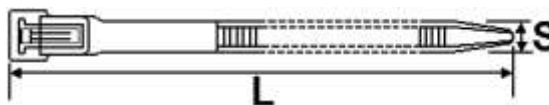
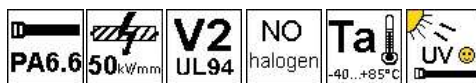

šifra artikla	naziv artikla		L x S (mm)		
492499	Vezica 200x 7,5 bijela NY		200 x 7,5 mm	10-50 mm	10-45 N
492500	Vezica 250x 7,5 bijela NY		250 x 7,5 mm	10-65 mm	10-45 N
492501	Vezica 300x 7,5 bijela NY		300 x 7,5 mm	10-70 mm	10-45 N
492502	Vezica 350x 8,0 bijela NY		350 x 8,0 mm	10-120 mm	10-45 N
492503	Vezica 200x 7,5 crna NY		200 x 7,5 mm	10-50 mm	10-45 N
492504	Vezica 250x 7,5 crna NY		250 x 7,5 mm	10-65 mm	10-45 N
492505	Vezica 300x 7,5 crna NY		300 x 7,5 mm	10-70 mm	10-45 N
492506	Vezica 350x 8,0 crna NY		350 x 8,0 mm	10-120 mm	10-45 N



Odvezive kabelske vezice sa grudicama

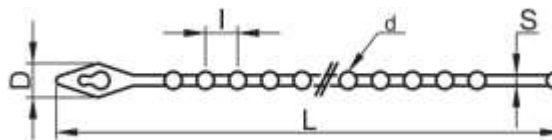
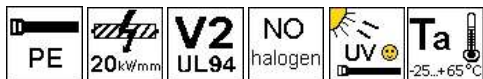

šifra artikla	naziv artikla		L x S (mm)	d (mm)	D (mm)	l (mm)		
492507	Vezica GY 100x 1,2 grudice WH		1,2 x 100	2,5	4,85	3	3 - 25 mm	45 N
492508	Vezica GY 120x 1,3 grudice WH		1,3 x 100	2,5	5,5	3	6 - 25 mm	40 N
492509	Vezica GY 150x 2 grudice WH		2 x 150	3	7,5	4,5	8 - 35 mm	40 N
492510	Vezica GY 150x 1,7 grudice WH		1,7 x 150	2,6	7,73	4	4 - 38 mm	40 N
492511	Vezica GY 180x 2 grudice WH		2 x 180	3	7,5	4,5	8 - 45 mm	40 N
492512	Vezica GY 200x 1,8 grudice WH		1,8 x 200	2,5	7,63	5	5 - 59 mm	40 N
492513	Vezica GY 100x 1,2 grudice BL		1,2 x 100	2,5	4,85	3	3 - 25 mm	40 N
492514	Vezica GY 120x 1,3 grudice BL		1,3 x 100	2,5	5,5	3	6 - 25 mm	40 N
492515	Vezica GY 150x 2 grudice BL		2 x 150	3	7,5	4,5	8 - 35 mm	40 N
492516	Vezica GY 150x 1,7 grudice BL		1,7 x 150	2,6	7,73	4	4 - 38 mm	40 N
492517	Vezica GY 180x 2 grudice BL		2 x 180	3	7,5	4,5	8 - 45 mm	40 N
492518	Vezica GY 200x 1,8 grudice BL		1,8 x 200	2,5	7,63	5	5 - 59 mm	40 N



Termootporne kabelske vezice

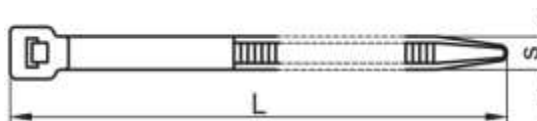

šifra artikla	naziv artikla		LxS (mm)			
491504	Vezica 365x 7,8 bijela		130 x 4,8	8 - 100 mm	135°C (5-8min)	250 N



Samogasive kabelske vezice

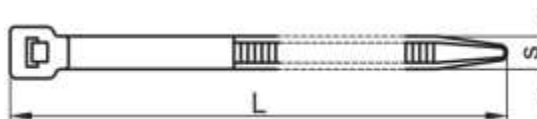

šifra artikla	naziv artikla		L x S (mm)		
492519	Vezica 150x 3,6 bijela SG		3,6 x 150	4 - 36 mm	80 N
492520	Vezica 200x 4,6 bijela SG		4,6 x 200	4 - 52 mm	110 N
492521	Vezica 300x 4,8 bijela SG		4 x 300	4 - 81 mm	110 N
492522	Vezica 380x 7,6 bijela SG		7,6 x 380	9 - 108 mm	250 N

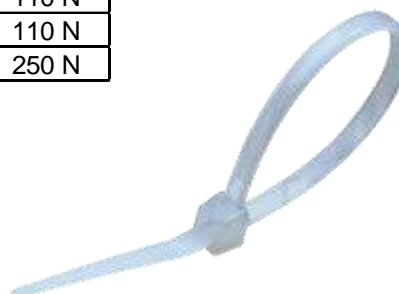

Kabelska vezica BK sa šiljkom

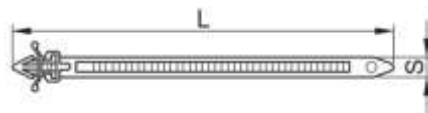
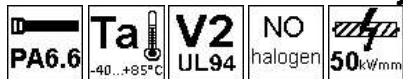

šifra artikla	naziv artikla		LxS (mm)		
492523	Vezica BK 130 x 4,8 bijela		130 x 4,8	d = 6 mm	200 N

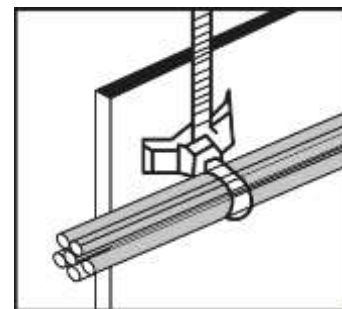

Kabelske vezice sa pločicom

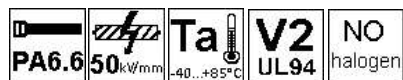

šifra artikla	naziv artikla		L x S (mm)	a (mm)	b (mm)		
490505	Vezica oznakom 110x2,5 bijela		110 x 2,5	8	25	1 - 20 mm	40 N
490506	Vezica oznakom 190x3,6 bijela		190 x 3,6	27	13	10 - 48 mm	70 N
490504	Vezica oznakom 200x2,5 bijela		210 x 2,5	15	30	5 - 45 mm	40 N

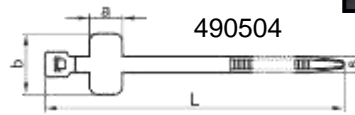
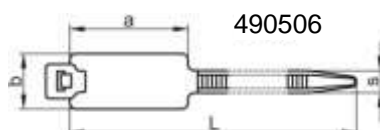

Čelične kabelske vezice

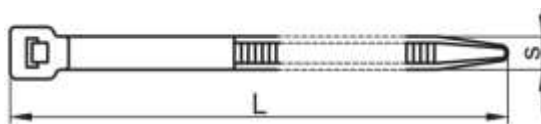

šifra artikla	naziv artikla	L x S (mm)		
491695	Vezica METALNA 125x4,6	125 x 4,6	15 - 38 mm	350 N
491696	Vezica METALNA 200x4,6	200 x 4,6	15 - 61 mm	350 N
491697	Vezica METALNA 200x7,9	200 x 7,9	15 - 61 mm	450 N
491698	Vezica METALNA 290x4,6	290 x 4,6	15 - 90 mm	350 N
491699	Vezica METALNA 290x7,9	290 x 7,9	15 - 90 mm	450 N
491700	Vezica METALNA 520x4,6	520 x 4,6	15 - 163 mm	350 N
491701	Vezica METALNA 520x7,9	520 x 7,9	15 - 163 mm	450 N
491702	Vezica METALNA 840x4,6	840 x 4,6	15 - 265 mm	350 N
491703	Vezica METALNA 840x7,9	840 x 7,9	15 - 265 mm	450 N



Kabelska vezica za vijčano pričvršćenje

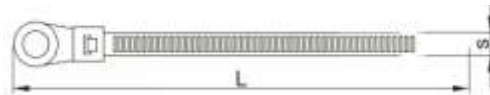
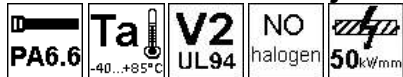

šifra artikla	naziv artikla	L X S (mm)			
491681	Vezica CS 110x2,5	110 x 2,5	3 - 19 mm	45 N	M2,5
491682	Vezica CS 150x3,6	150 x 3,6	3 - 35 mm	80 N	M4
491683	Vezica CS 160x4,8	160 x 4,8	3 - 36 mm	110 N	M5
491684	Vezica CS 200x4,8	200 x 4,8	3 - 49 mm	110 N	M5
491685	Vezica CS 300x4,8	300 x 4,8	3 - 82 mm	110 N	M5
491686	Vezica CS 300x7,6	300 x 7,6	8 - 78 mm	250 N	M6
491687	Vezica CS 370x4,8	370 x 4,8	3 - 103 mm	110 N	M5
491688	Vezica CS 400x7,6	400 x 7,6	8 - 109 mm	250 N	M6



Kabelska vezica sa CLIP držačem



šifra artikla	naziv artikla	L X S (mm)		
491535	Vezica CLIP 200 x 4,8	200 x 4,8	3 - 49 mm	110 N



Kabelske vezice na čičak

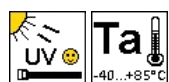

šifra artikla	naziv artikla	L x S (mm)	
491675	Vezica TKR 200x12,5 čičak	130 x 12,5	35 mm
491676	Vezica TKR 130x12,5 čičak	200 x 12,5	35 mm
491677	Vezica TKR 300x12,5 čičak	300 x 12,5	89 mm
491678	Vezica TKR 310x17 čičak	300 x 17	92 mm
491679	Vezica TKR-T 22x12 čičak	22,8m x 12,5mm	-
491680	Vezica TKR-T 25x25 čičak	25m x 20mm	-



Nosač vezica vijčani za kabelske vezice



šifra artikla	naziv artikla	a (mm)	b (mm)	L (mm)	d (mm)	D (mm)
492658	Nosač vezica VJ2 15x10	15	10	5,1	3,5	7
492659	Nosač vezica VJ2 23x16	23	16	9	6,3	9,8
492660	Nosač vezica VJ2 12x7	12,8	7	4	3,3	5,8
492661	Nosač vezica VJ2 16x11	16	11	5,3	3,5	7
492662	Nosač vezica VJ2 22x15	22	15	8,3	5	9,5
492663	Nosač vezica VJ2 26x16	26	16	9,5	5	10,7

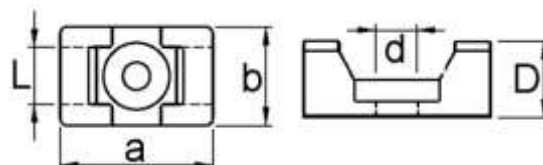

Nosač vezica dvostrani samoljepljivi

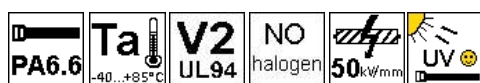

šifra artikla	naziv artikla	color	a (mm)	b (mm)	L (mm)	d (mm)	D (mm)
492654	Nosač vezica LJ2 19x19 bijela	color	18,7	18,7	4	4,4	5,7
492655	Nosač vezica LJ2 19x19 crni		18,7	18,7	4	4,4	5,7
492656	Nosač vezica LJ2 26x26 crni		26,5	26,5	5,8	4,3	8,1
492657	Nosač vezica LJ2 26x26 bijela		26,5	26,5	5,8	4,3	8,1

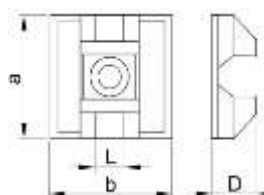

Nosač vezica četverostrani samoljepljivi



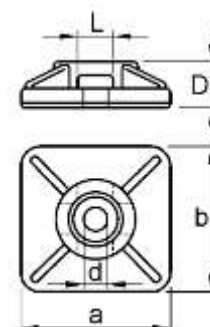
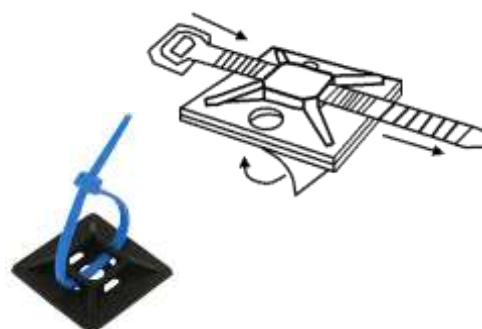

šifra artikla	naziv artikla	color	a (mm)	b (mm)	L (mm)	d (mm)	D (mm)
492695	Nosač vezica LJ4 20x20 bijela	color	20	20	5	2,9	6,1
492697	Nosač vezica LJ4 20x20 crni		20	20	5	2,9	6,1
492696	Nosač vezica LJ4 19x19 bijela		19	19	4,3	5	6
492698	Nosač vezica LJ4 19x19 crni		19	19	4,3	5,7	6,5
492699	Nosač vezica LJ4 25x25 bijeli		25	25	6,2	3,5	7,5
492701	Nosač vezica LJ4 25x25 crni		25	25	6,2	3,5	7,5
492700	Nosač vezica LJ4 28x28 bijeli		28	28	5,2	5,7	6,5
492702	Nosač vezica LJ4 28x28 crni		28	28	5,2	5,7	6,5



Tiple sa nosačem



šifra artikla	naziv artikla			a (mm)	b (mm)	c (mm)	W1 (mm)	W2 (mm)	L (mm)	D (mm)
492690	Tipla s nosačem 8x44 crna		8 mm	10,6	6,3	3,1	12,8	12,6	43,8	9,9
492691	Tipla s nosačem 9,9x38 crna		7 mm	10,2	6,4	3	14,6	11	38	9,9
492692	Tipla s nosačem 8x43 crna		8 mm	10,3	6,5	3,2	12,8	12,9	43,3	9,7
492694	Tipla s nosačem 7,9x38 crna		7 mm	9,8	6,4	2,1	15,4	11,1	38	7,9

